

copyright © asupra editiei
in limba romana:

Edilizia Tools - distribuitor autorizat Ozgenc®

www.utilaje-ozgenc.com







OMRM-136

MASINA DE SERTIZAT PROFILE ALUMINIU

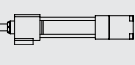
UTILAJE  PERFORMANTE

Aplicatii / utilizari:

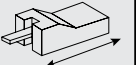
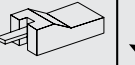
Pentru imbinarea profilelor din aluminiu
la 90° prin sertizare

OMRM-136	FEATURES											
												
METRIC	Hydropneumatic pressure Bar	Bar	Air consumption (lt/min)	Kg	H (mm)	W (mm)	D (mm)	Crimping force kg*f	Crimping tools stroke (mm)	Max. crimping height (mm)	Crimping tools ad. in cross directions (mm)	Profile baking block stroke (mm)
	100-120	6-8	12	380	1225	850	900	3250	25	140	60	140

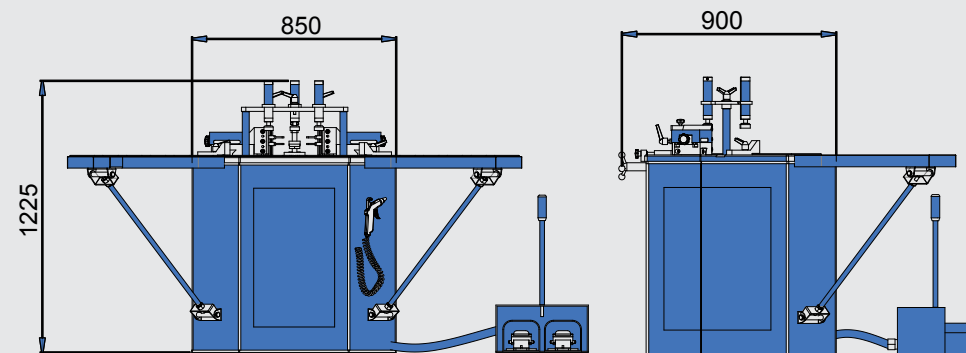

Caracteristici :

- Echipament utilizat la imbinarea profilelor din aluminiu prin procedeul de sertizare
- Actionare pneumatica (nu necesita racord la energie electrica)
- Kituri echipate cu seturi de cutite ajustabile pe 3 axe
- Sistemul pneumatic cu care este dotat echipamentul asigura deplasarea uniforma si sincrona a cutitelor de sertizare
- Mecanism opritor care ajuta la fixarea facila a coltului
- Cap hidro-pneumatic orizontal cu revenire in interiorul masinii care, dotat cu bacurile aferente profilului, asigura o aliniere si presare perfecta a profilelor ce urmeaza a fi sertizate
- 3 menhine pneumatice verticale care contribuie la fixarea profilelor
- Kiturile de sertizare asigura o reglare precisa si rapida a cutitelor ceea ce face ca acest mecanism sa fie usor adaptat pentru orice tip de profil
- Alinierea profilelor pe bratele laterale sa face cu opritori reglabili cu blocare manuala

Echipping standard:

- 2 kituri dotate cu seturi de cutite de 4/6 mm
- Brate de sustinere a profilelor, ajustabile
- 2 pedale de actionare

