

copyright © asupra editiei
in limba romana:

Edilizia Tools - distribuitor autorizat Ozgenc®

www.utilaje-ozgenc.com







TURBOWELD-400

Centru CNC de sudura la 4 capete si debavurare

UTILAJE  PERFORMANTE

Aplicatii / utilizari:

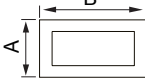
Pentru sudarea la 4 capete simultan a profilelor
din PVC si debavurarea colturilor, cu CNC

TURBOWELD-400	FEATURES		METRIC		Bar		Air consumption (lt/syc.)		Kg		H (mm) W (mm) D (mm)			Ø D (mm) Ø d (mm) w (mm)			A min /max B min /max		a max (mm) a min (mm) b max (mm)				
								V	kW	6 - 8	180 lt/syc.	4000	2220	13000	5700	250	30	4,3 / 4	420 3650	390 2650	180	40	130

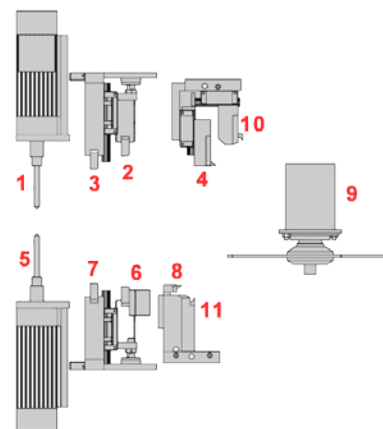

Caracteristici :

- Linie automata de sudura si debavurare compusa din:
 - Masina de sudat la 4 capete automata, cu pozitionare prin setarea cotelor la touch-screen sau cititor coduri de bare
 - Linie de transport motorizata, automata, la masina de debavurat
 - Sistem de rotire automata a ramei
 - Masina de debavurat cu CNC
 - Capacitate de productie de aprox. 250 rame/schimb
 - Asistenta tehnica prin internet (remote)

Modulul de sudura:

- Realizeaza sudura la 4 capete simultan
- Sistem de schimbare rapida a foliei de teflon, pe tamburi rotativi
- Sistem centralizat de lubrefiere a mecanismelor de deplasare
- Modulul de debavurare:**
 - Executa debavurarea pe suprafete, colt exterior si zonele interioare ale coltului, cu ajutorul a 11 scule
 - Poate efectua si deplasari ale sculelor pe arce de cerc (util pentru profile curbate)
 - Sistem facil de programare si de invatare astfel incat programele sa poate fi create si de catre beneficiar

- 4 cutite de debavurat suprafete (2 alb, 2 colorat)
- 4 cutite tip "gheara" pentru zolene interne
- 2 freze pentru canalul de garnitura
- 1 freza disc pentru coltul extern
- Optionale:**
 - Sistem pentru limitarea sudurii garniturilor
 - Integrare cu diverse programe software de productie