

copyright © asupra editiei
in limba romana:

Edilizia Tools - distribuitor autorizat Ozgenc®

www.utilaje-ozgenc.com





OMRM-122

MASINA DE SUDAT LA 4 CAPETE

UTILAJE  PERFORMANTE

Aplicatii / utilizari:

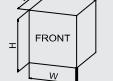
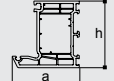
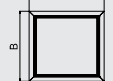
Pentru sudarea profilelor din PVC la
4 capete simultan

OMRM 122	FEATURES							
	METRIC	3 ph 10Kw 30A 50/60 Hz 380V AC	Bar 6-8	Air consumption (lt/min) 200 - 250	Kg 2200	H (mm) 1500 W (mm) 4250 (6500) D (mm) 5200	h min (mm) 40 h max (mm) 180 a min (mm) - a max (mm) 120	A max (mm) 3650 A min (mm) 420 B max (mm) 2650 B min (mm) 390

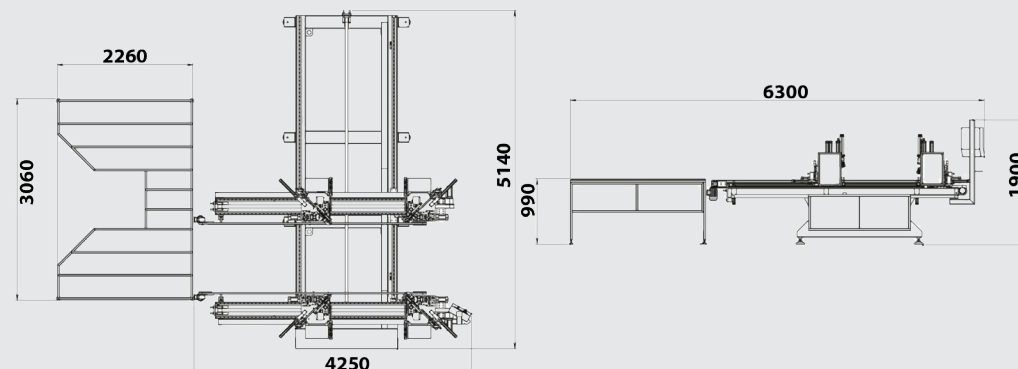
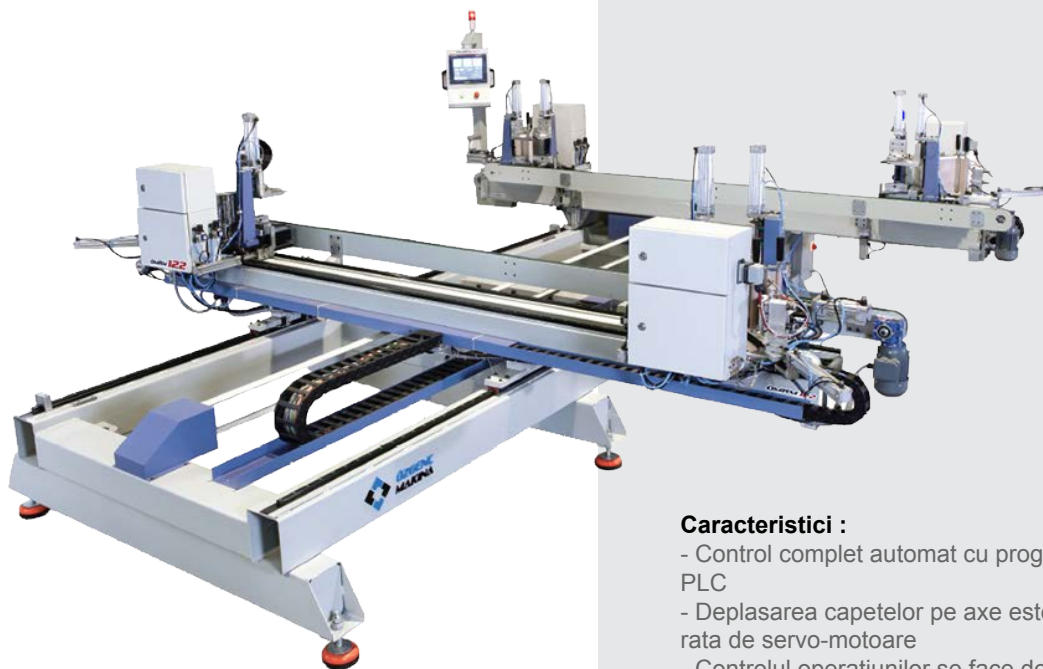

Caracteristici :

- Control complet automat cu programator PLC
- Deplasarea capetelor pe axe este asigurata de servo-motoare
- Controlul operatiunilor se face de la display tip touch-screen de 10 inch
- Cititor de coduri de bare care asigura pozitionarea la dimensiunile ce urmeaza fi sudate
- Integritate cu masina de debavurat cu CNC pentru a forma o linie de sudare-debavurare
- Posibilitatea de integritate cu software de productie
- Mod usor si practic de introducerea parametrilor de lucru
- Sistem de inlocuire rapida a foliei de teflon, cu tamburi rotativi
- Mod de lucru in plan orizontal
- Posibilitatea de a suda atat profile albe cat si colorate

- Control digital al temperaturii
- Sistem rapid de schimbare a bacurilor ce reduce pierderile de timp necesare acestei operatiuni
- Ajustarea facila a timpilor de topire si sudare, a presiunii si temperaturii, in functie de tipul de profil
- Sistem centralizat de lubrefiere a sistemelor de deplasare liniara
- Sistemele de deplasare liniara sunt asigurate de servo-motoare
- Capacitate de productie intre 180-240 cadre/schimb

